

Maintenance & Operating Instructions

For
Dixon Bayco
FT300 SERIES SOCKETS

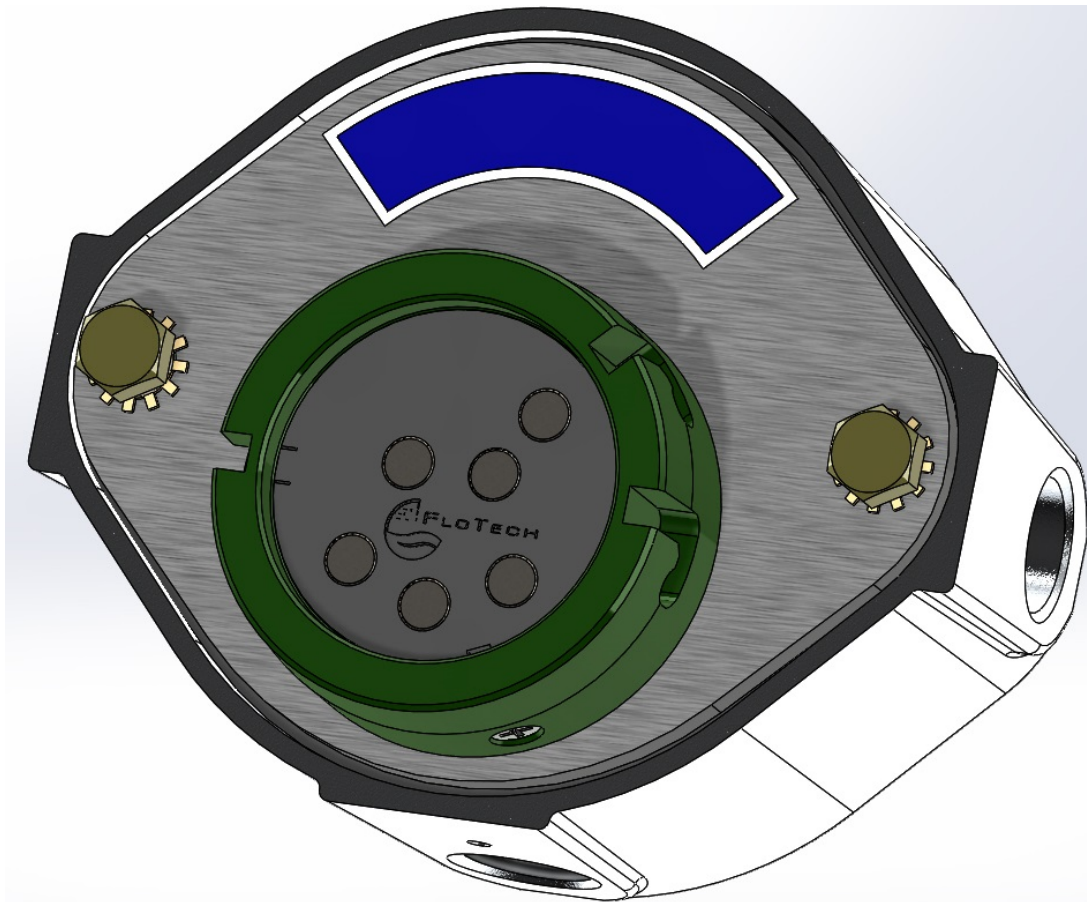

The Right Connection®

dixonvalve.com

FloTech sockets are mechanically and functionally compatible with API 1004 Cargo Tank Bottom Loading Recommended Practice. Socket faceplate and contact components are interchangeable with Scully and Civacon socket bodies. Civacon is the registered trademark of Civacon / Dover Corporation.

INSTALLATION INSTRUCTIONS:

Sockets are to be mounted on the same side of the trailer as the bottom loading equipment. Sockets are normally located within 3 feet of the bottom loading adapters so the rack plug and cord will reach the socket without over stretching the cord. Remove the socket faceplate and hardware packet and set aside. Use the socket body as a template to drill two 11/32" holes as shown in Diagram 1. Mount the socket body to the trailer using two 5/16 bolt and lock washers. Make sure the grounding wire, large eyelet end is fastened under one of the 5/16 bolts.

DIAGRAM 1

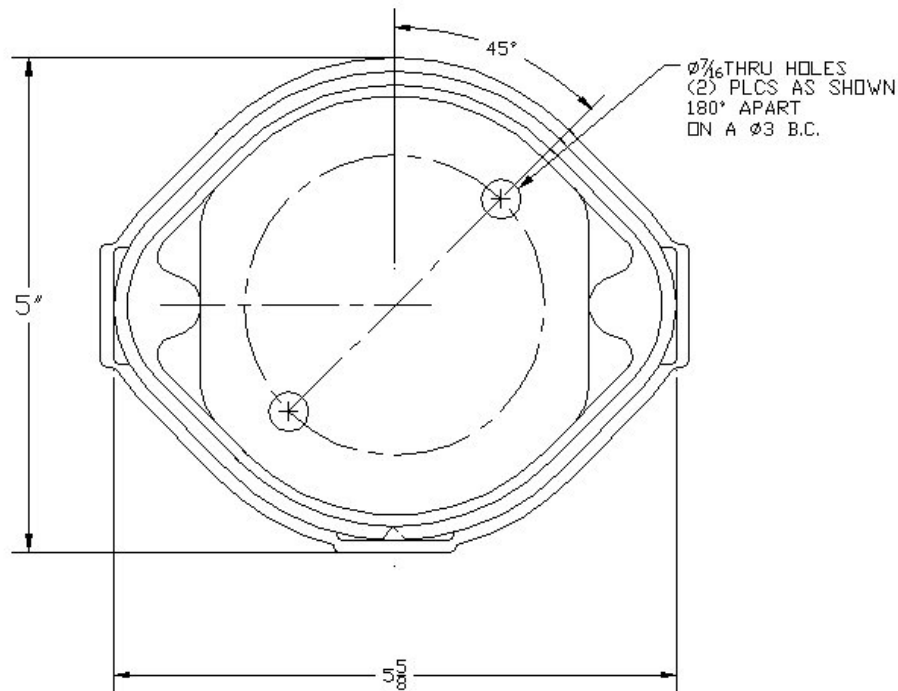

WIRING INSTRUCTIONS:

When wiring the sockets to an onboard monitor it is highly recommended using FloTech FT401 jacketed 5-conductor cable when wiring a new system. FloTech cable is designed to be oil, UV, and abrasion resistant. We incorporate a noble tin-plated stranded copper wire which resists corrosion. These features will provide years of reliable service.

After all sensors are mounted in each compartment, align the conduit openings so they face the roll over rail. Thread in cable glands and pull a length of cable through the conduit openings between each sensor. Cut to length leaving approximately 8 inches extra length exiting the top of each probe holder.

FOR SOCKETS USING NPT SIDE OPENINGS:

All socket cables must enter or leave through one of the ½ NPT openings. Use FloTech FT402 ½ NPT cable glands to ensure a water tight seal. Unused conduit openings must have a ½ NPT pipe plug installed. Use pipe dope on all ½ NPT threads to ensure a water tight seal.

FOR EUROPEAN SOCKETS USING METRIC M20 X 1.5 SIDE OPENINGS:

All socket cables must enter or leave through one of the M20 X 1.5 threaded openings. Use FloTech FT402E M20 X 1.5 cable glands with thread sealant to ensure a watertight seal. Unused conduit openings must have a M20 X 1.5 plug with o-ring installed.

Wire the sockets according to diagram 2 below. Double check your wiring connection when complete. NOTE: It is highly recommended to use a small amount of Silicone RTV sealant in each crimp connection. Fill the FloTech butt end crimps with Silicone RTV sealant prior to inserting the wires then crimp. This will provide a watertight and vibration resistant connection.

When wiring is complete, replace each sensor cap and o-ring. CAUTION: Do not pinch a sensor wire when installing the cap.

For Technical Assistance Call 877 582 3569

DIAGRAM 2

FLOTECH OPTIC SOCKETS

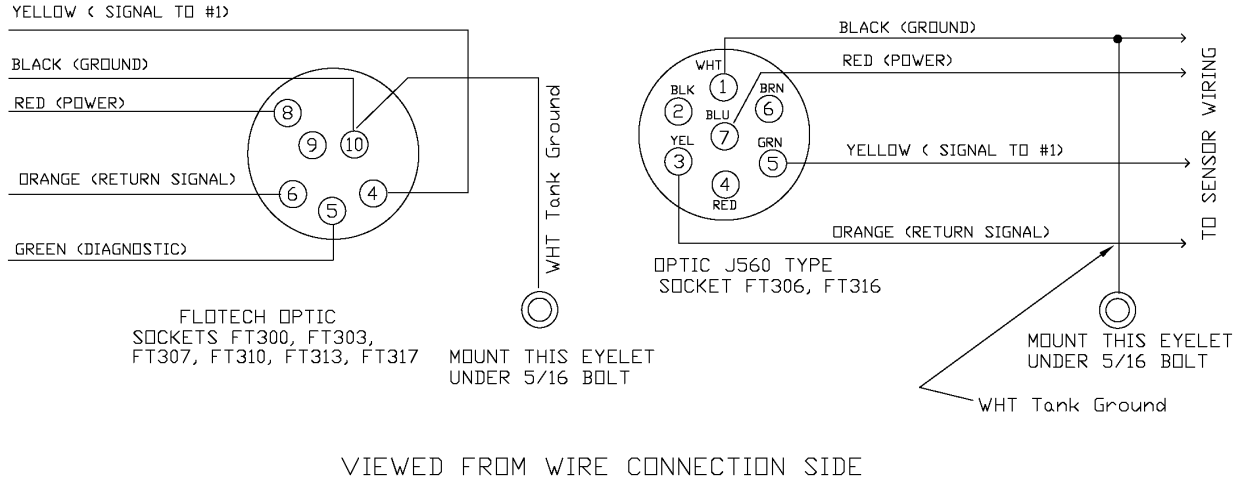

If your socket contains an installed grounding device, install the free end of the device under one of the mounting screws as shown.

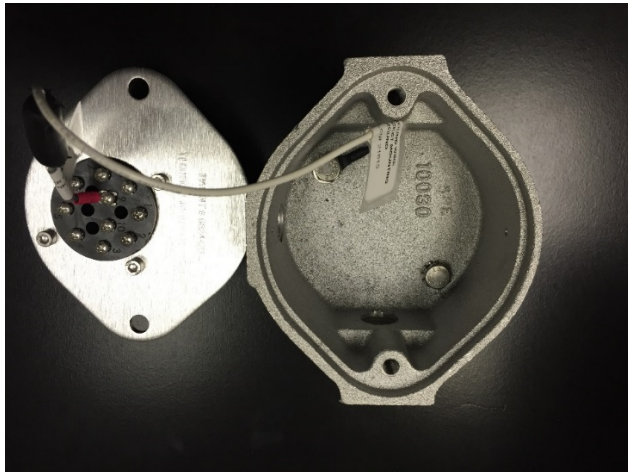

Grounding Device

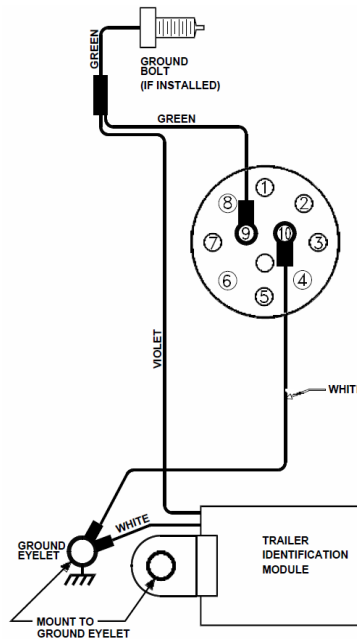
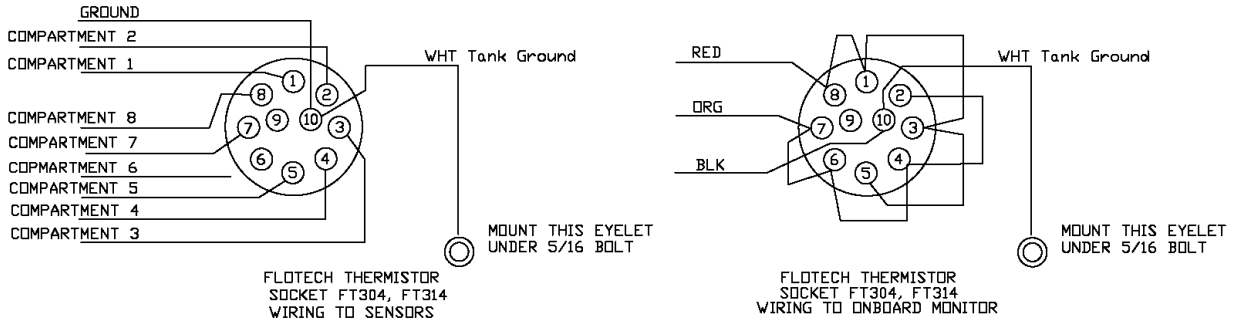
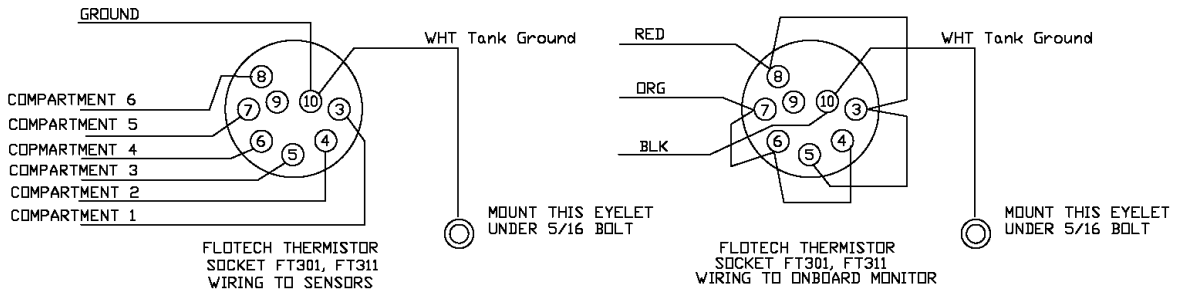

DIAGRAM 2 (CONTINUED)

FLOTECH THERMISTOR SOCKETS



VIEWED FROM WIRE CONNECTION SIDE



VIEWED FROM WIRE CONNECTION SIDE

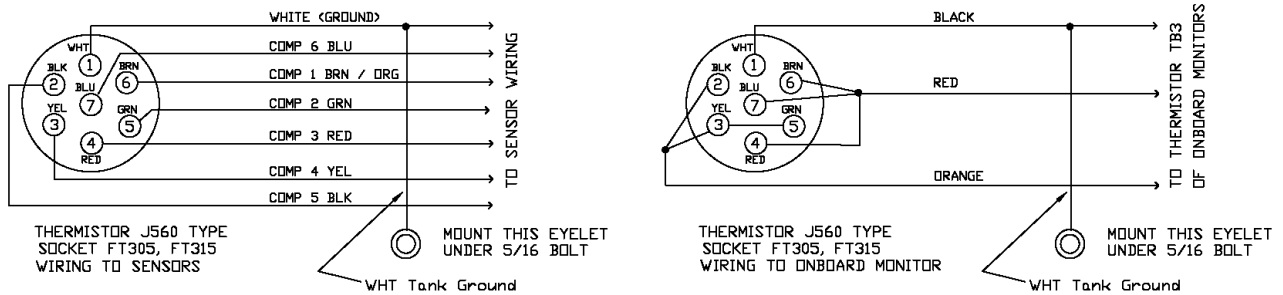

FLOTECH FLOAT SOCKET

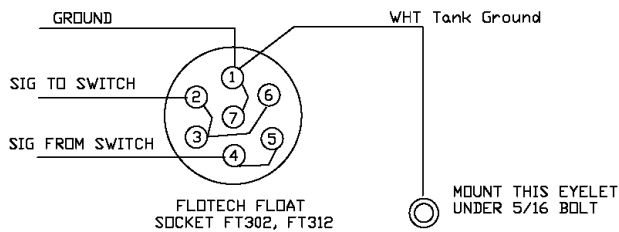

VIEWED FROM WIRE CONNECTION SIDE

For Sales and Service Contact

Europe:
Dixon Group Europe Ltd.
Preston, England
Phone: +44 (0) 1772 323529
Fax: +44 (0) 1772 314664
Email: enquiries@dixoneurope.co.uk

Mexico:
Dixva, S. de R.L. de C.V.
Monterrey, N.L.
Phone: 01-800-00-DIXON (34966)
Fax: 01-81-8354-8197
E-mail: contactenos@dixonvalve.com.mx

Canada:
Dixon Group Canada Limited
Innisfil (Barrie), Ontario
Phone: 705-436-1125
Fax: 705-436-6251
Toll Free: 877-963-4966
E-mail: isales@dixongroupcanada.com

Asia Pacific:
Dixon (Asia Pacific) Pty Ltd Wingfield,
South Australia
Phone: +61 8 8202 6000
Fax: +61 8 8202 6099
E-mail: enquiries@dixonvalve.com.au

USA:
Dixon Bayco USA
Chestertown, Maryland
Phone: 410-778-2000
Fax: 410-778-4702
Toll Free: 800-355-1991
E-mail: dixonbayco@dixonvalve.com



The Right Connection®

dixonvalve.com