

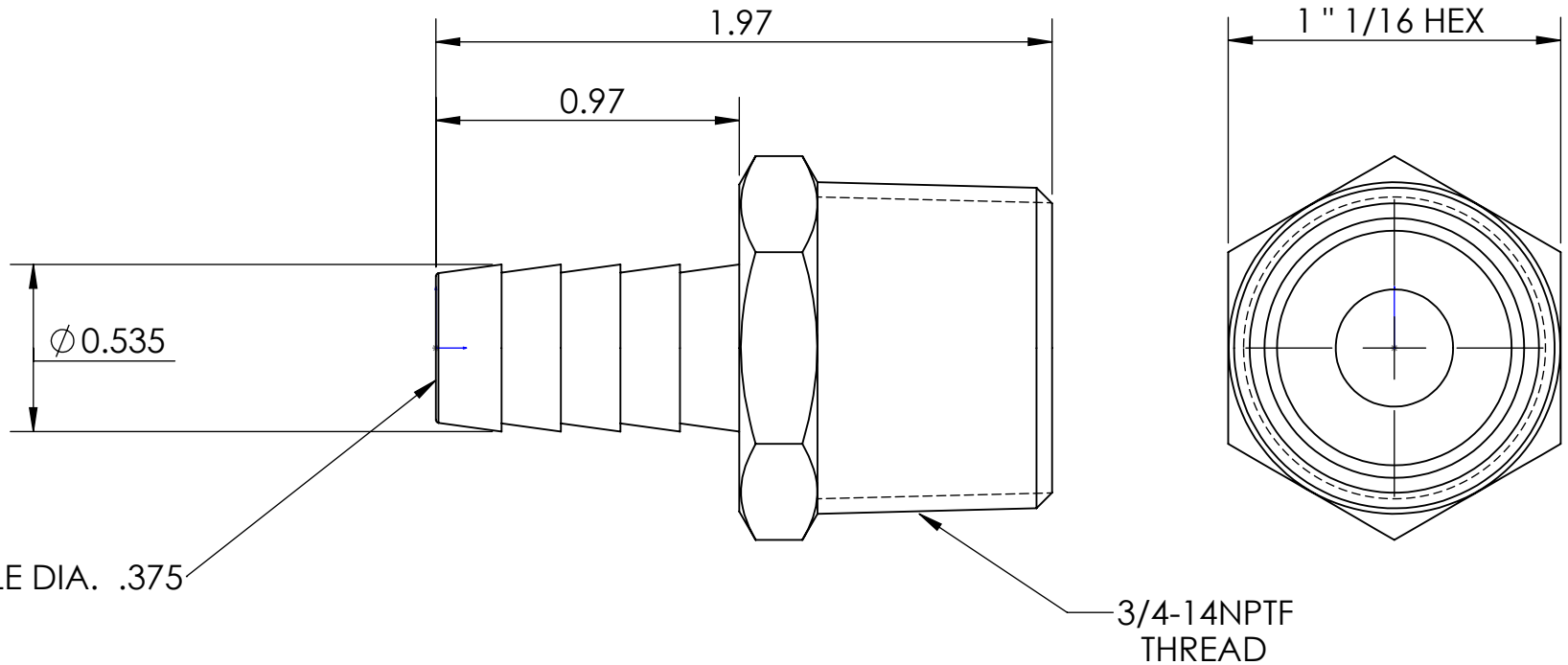

LINE DRAWING NOT FOR PRODUCTION PURPOSES

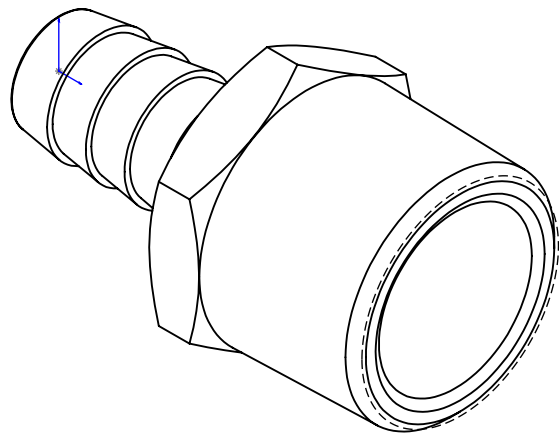

THRU HOLE DIA. .375

3/4-14NPTF
THREAD



THIS DRAWING CONTAINS INFORMATION DEEMED PROPRIETARY TO DIXON BRASS AND IS SO TO BE USED ONLY FOR THE PURPOSE FOR WHICH IT IS SUBMITTED, AND FURTHER, SHALL NOT BE COPIED IN WHOLE OR IN PART WITHOUT EXPRESS WRITTEN PERMISSION FIRST OBTAINED FROM DIXON BRASS.				
UNLESS OTHERWISE SPECIFIED:		 Dixon Brass Westmont, Illinois USA	DRAWN P. MONAGHAN APPROVED	DATE 10/28/13 DATE
DIMENSIONS ARE IN INCHES TOLERANCES: ANGLES: ±0°30' .X (±.015) .XX (±.010) .XXX (±.005) DIMENSIONS PER ANSI Y14.5			ECO NO.	
TITLE: 1/2 MALE HOSE BARB X 3/4 - 14 NPTF		DRAWING NOT REPRODUCED TO SCALE		
SIZE A	DWG. NO. 1020812C	REV D		